

Introduction	BOND:2
Equipotential Bonding An important aspect of a Lightning Protection System	BOND:3 - 4
Bonds B Bonds, RWP Bonds, Pipe Bonds and Reinforcing Bonds	BOND:5
Tower Earth Clamps Bond copper or aluminium conductor to flat metal surfaces	BOND:6
Earth Points Single, two and four hole Earth Points and Static Earth Receptacles	BOND:7 - 8
Earth Bosses and Static Earth Receptacles Used for welding to steel vessels, tanks and structures etc	BOND:9
Flexible Flat Braid Bonds Ideal for bonding of metal doors, gates, fencing etc	BOND:10 - 11
Flexible Circular Braid Bonds Terminated with pressed ferrule connectors at each end Suitable for bonding gates, doors, fences etc	BOND:12
Flexible Flat Copper Braids Flexible Flat Copper Braid is suitable for applications of earth bonding	BOND:13
Expansion Bonds and Split Bolt Connectors Absorb movement caused by the electromechanical effects of a direct lightning strike	BOND:14 - 15
C Crimp Connectors	BOND:16
Isolating Spark Gaps Encapsulated high-performance Isolating Spark Gaps	BOND:17 - 18

Introduction

Kingsmill provide a range of products for effective bonding of electrically conductive components to the Lightning Protection System.

BRAID BONDS
pages BOND:10 - 15



ISOLATING SPARK GAPS
pages BOND:17 - 18

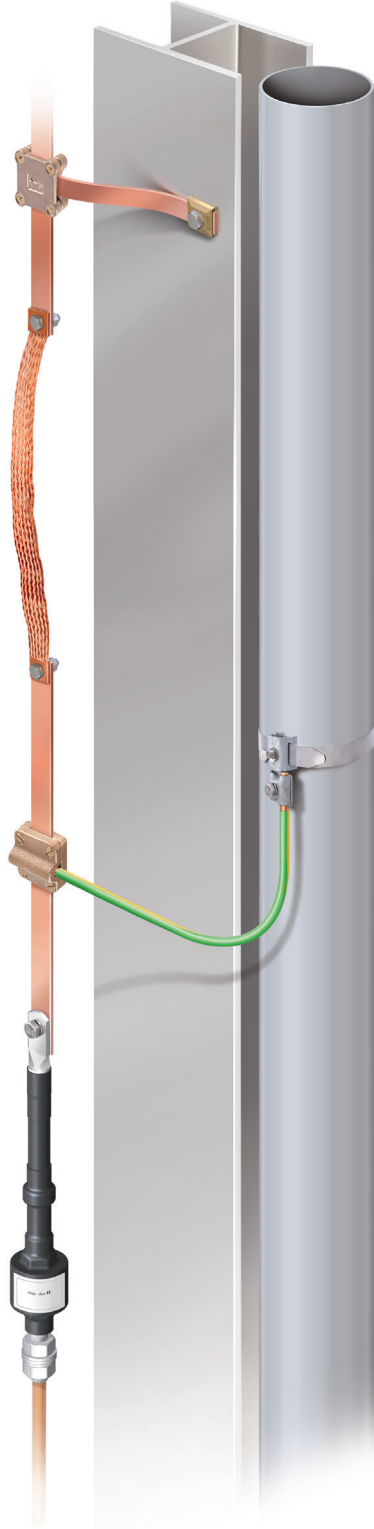

B BONDS
page BOND:5



PIPE BONDS
page BOND:5



REINFORCING BONDS
page BOND:6



STEEL BEAM BONDS
page BOND:6



STATIC EARTH RECEPTACLES
page BOND:9



Equipotential Bonding

An important aspect of a Lightning Protection System (LPS) is that electrically continuous parts of a structure must be bonded into the Lightning Protection network. The purpose of this bonding is to ensure that, in the event of a lightning discharge, any sparking or flashover of the lightning current to conductive parts of the structure, for example water pipes, cables etc is avoided. This is illustrated in the diagram, *to the right*.

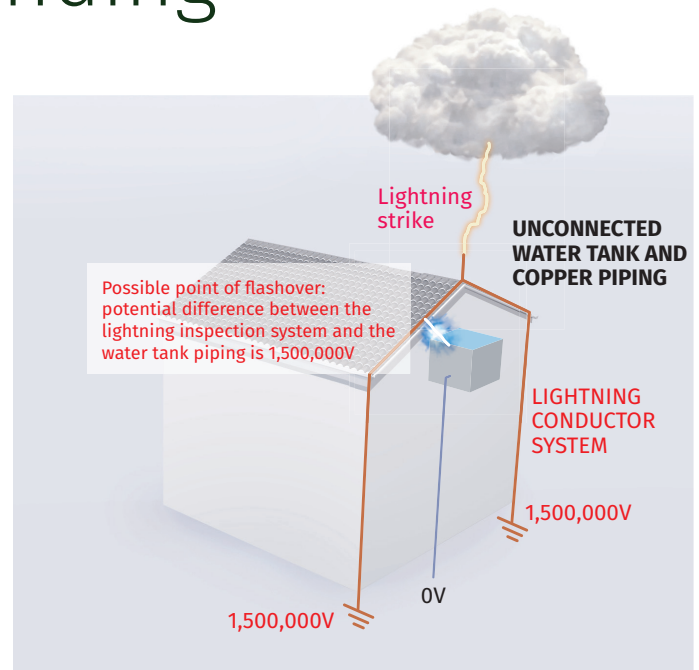

EXPLANATION:

During a lightning strike the lightning conductor system could reach 1,500,000 volts with respect to earth, whilst the copper piping connected to the water tank is at 0 volts to earth. The impedance of the lightning conductor system will determine the “potential difference” between the two systems with respect to earth, as well as the distance that the water tank is away from the lightning conductor. If the potential difference is large enough, it may cause breakdown of the insulation effects of the roof and air, leading to a spark flashing over to the water tank.

Equipotential bonding in this respect, is essentially the connection of conductive metallic parts of the structure such that in the event of a lightning discharge, no potential differences exist between the lightning conductor system and the “other conductive low impedance pathways”.

Materials that can provide a fortuitous low impedance pathway and may require bonding into the lightning protection system are such as:

- Cable screens
- Metallic pipework
- Metallic handrails, stairways, screens
- Structural steelwork
- Reinforcing bar
- Metallic cladding systems for buildings
- Supporting structures for curtain wall systems
- Ductwork etc

The risk of flashover can increase in the presence of:

- Incorrect routeing of conductors
- High impedance lightning protection system - due to the installation of poorly designed components, or inferior/corrosion prone materials

From BS:EN 62305 . . .

Some implications for bonding

In a well-designed system, all metallic/conductive services, such as water and gas pipes, power, telecommunications and data cables would enter the building in the same locality and be connected to a single earth bonding bar. Which, in turn, would be connected to the earth termination network, as well as the conductive parts of the building.

However, life isn't that simple and services enter and exit at different places. It is recommended that services are bonded at their point of entry to/exit from the building.

Equipotential bonding can be achieved through:

Direct Connection

Utilising bonds, clamps and conductors which link the various metallic services and parts of the structure to Earth Bars.

The standard outlines the minimum cross-sectional area of conductors to be used in these applications.

Earth Bars act as collection points for the various bonds and their subsequent connection to the earth termination. Each Earth Bar would be connected to earth. **See Earth Bar section.**

Surge Protection Devices (SPDs)

It is recommended that the live cores of power, telecommunication and data cables are equipotentially bonded through using appropriately rated Surge Protective Devices.

A simplified illustration of equipotential bonding using SPDs is demonstrated here . . .

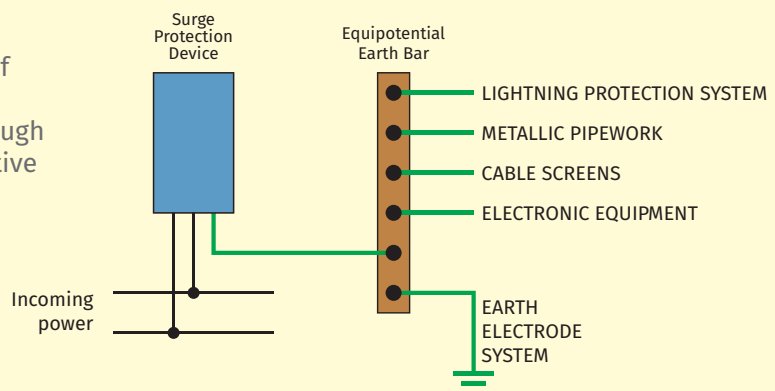

Guidance for the selection of equipotential bonding or lightning current SPDs can be found on pages SPD:11 - 26.

Isolating Spark Gaps (ISGs)

Are suitable for use where the direct connection of an external Lightning Protection System and other metallic parts or earthing system is not allowed due to operating reasons. For example, earthing systems for heavy current and telecommunications systems or bridging isolated flanges on pipe connections.

When a difference in potential occurs between these parts, the Isolating Spark Gap (ISG) will provide a temporary conductive connection to earth, thus reducing dangerous potential difference issues (see page EAR:4 for a simple explanation of potential difference).

Kingsmill offer a wide range of bonding solutions:

- Mechanical Bonds and Clamps
- Earth Bars
- Conductors
- Surge Protection Devices
- Isolating Spark Gaps

Please contact the Kingsmill sales and technical support team to ensure that you are using high quality products specifically designed for purpose.

B Bonds (Flat surfaces)

Kingsmill 'B' Type Bond connections are designed to bond either copper or aluminium conductor to flat metal surfaces.

CONDUCTOR MATERIAL	CONDUCTOR SIZE (mm)	MATERIAL	BOLT SIZE	WEIGHT (kg)	PART NO.
Copper	25 x 3	Gunmetal	M10	0.08	BBCB
Aluminium	25 x 3	Aluminium	M10	0.06	BBAB
Copper	31 x 6	Gunmetal	M10	0.14	BBCB316

Material: Gunmetal or Aluminium (body)
Stainless Steel (bolt)

Standard: BS:EN 62561-1 Class H, BS 7430

Tightening torque: 17Nm

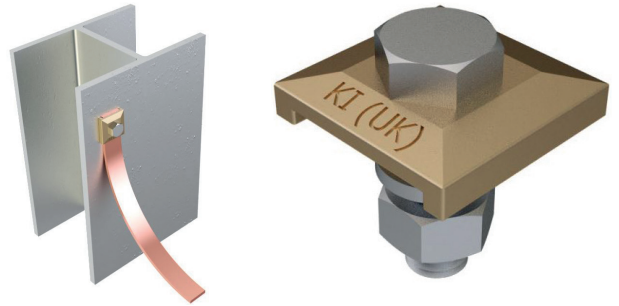

RWP Bonds (Pipe work)

RWP Bonds connect flat conductor to circular objects eg pipework and hand rails etc. RWP Bonds are available in either gunmetal or aluminium to suit your application.

CONDUCTOR MATERIAL	CONDUCTOR SIZE (mm)	MATERIAL	BOLT SIZE	WEIGHT (kg)	PART NO.
Copper	25 x 3	Gunmetal	M10	0.19	CRWB
Aluminium	25 x 3	Aluminium	M10	0.09	ARWB
Copper	31 x 6	Gunmetal	M10	0.25	CRWB316

Material: Gunmetal or Aluminium (body), Stainless Steel (bolt)

Standard: BS:EN 62561-1 Class H, BS 7430

Tightening torque: 12Nm

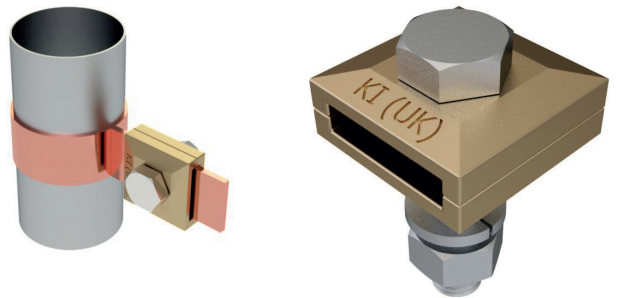

Pipe Bonds

Kingsmill Pipe Bonds are designed for bonding circular stranded copper or aluminium conductor to pipework.

CONDUCTOR SIZE	PIPEWORK SIZE	WEIGHT (kg/m)	PART NO.
10mm ² - 50mm ² (up to 8mm dia)	1" - 3" (33.7mm - 88.9mm)	0.073	PBS1-3
10mm ² - 50mm ² (up to 8mm dia)	3" - 6" (88.9mm - 168mm)	0.177	PBS1-6

Material: Galvanised Steel/Steel

Standard: BS:EN 62561-1



Tower Earth Clamps

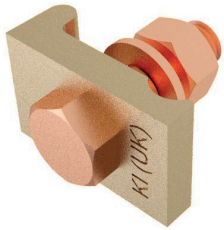

TEC2550

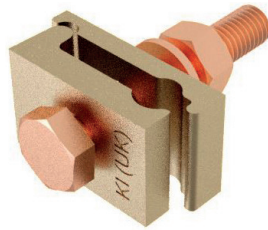

TEC1670

Kingsmill **Tower Earth Clamps** are designed to bond either copper or aluminium conductor to flat metal surfaces.

DESCRIPTION	CONDUCTOR SIZE RANGE (mm ²)	CONDUCTOR MATERIAL	WEIGHT (kg)	PART NO.
Single Plate Clamp	25 - 50	Copper	0.08	TEC2550
Single Plate Clamp	25 - 50	Aluminium	0.06	TEA2550
Double Plate Clamp	16 - 70	Copper	0.13	TEC1670
Double Plate Clamp	70 - 120	Copper	0.23	TEC70120

Material: Copper or Aluminium (body), Brass (bolt)

Standard: BS:EN 62561-1 Class H, BS 7430

Tightening torque: 12Nm



Reinforcing Conductor Clamps



KMRC20

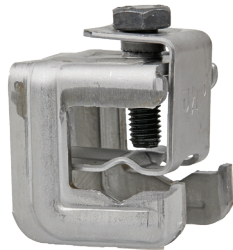

KMRC20-P

Kingsmill **Reinforcing Conductor Clamps** are used to connect flat and circular conductor to reinforcing bar.

REBAR SIZE (mm ²)	CIRCULAR CONDUCTOR	FLAT CONDUCTOR (mm)	WEIGHT (kg)	PART NO.
6 - 20	N/A	25 x 3 - 30 x 3.5	0.21	KMRC20
6 - 20	8 - 10mm dia	25 x 3 - 30 x 3.5	0.26	KMRC20-P
25	8 - 10mm dia	25 x 3 - 30 x 3.5	0.20	KMRC25-P
30	N/A	25 x 3 - 30 x 3.5	0.15	KMRC30

Material: Zinc Plated Steel

Standard: BS:EN 62561-1

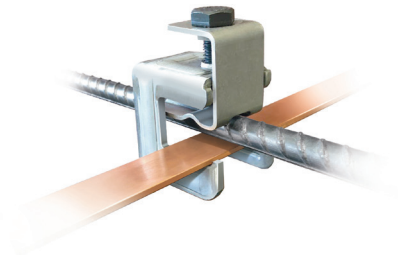

Steel Beam Conductor Clamp

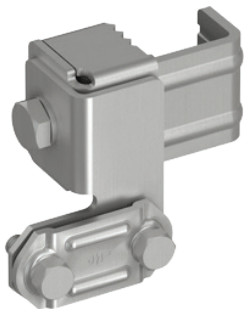

Steel Beam Conductor Clamps for fixing conductor to steel beams.

CONDUCTOR RANGE	CLAMPING RANGE (mm)	WEIGHT (kg)	PART NO.
Up to 30 x 3.5mm	36 - 52	0.44	KM111739

Material: Stainless Steel

Standard: BS:EN 62561-1

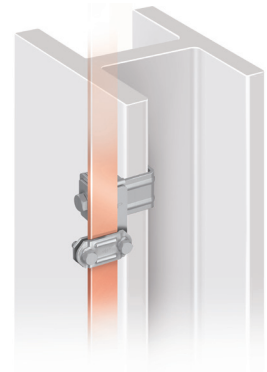

Earth Points (without cover plate)

Kingsmill **Earth Points** (without cover plate) provide a convenient bonding point for bolted connections.

HOLES	FIXING HOLES	MATERIAL	STEM SIZE (Ø)	WEIGHT (kg)	PART NO.
1	M8	Gunmetal	10mm	0.170	EBP1-M8
1	M10	Stainless Steel	10mm	0.217	EBP1SS-M10
1	M10	Gunmetal	10mm	0.170	EBP1
2	M10	Gunmetal	10mm	0.300	EBP2
4	M10	Gunmetal	10mm	0.350	EBP4

Material: Gunmetal/Stainless Steel

Standard: BS:EN 62561-1 Class H, BS 7430

Tightening torque: 8Nm



EBP4

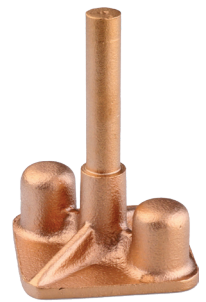

EBP2

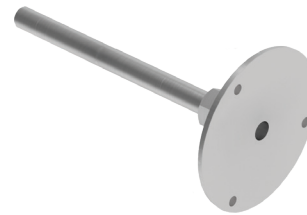

EBP1SS-M10



EBP1

Earth Points (with cover plate)

Kingsmill **Earth Points** (with cover plate) provide a convenient bonding point to reinforcing bar.

CONDUCTOR SIZES	MATERIAL	STEM SIZE (Ø)	WEIGHT (kg)	PART NO.
25 x 3 / 70mm ²	Gunmetal	10mm	0.42	EBP2P
25 x 3 / 50mm ² (8mm Ø)	Gunmetal	10mm	0.42	EBP2P-08

Material: Gunmetal

Standard: BS:EN 62561-1 Class H, BS 7430

Tightening torque: 8Nm



Earth Points (with green/yellow tail)

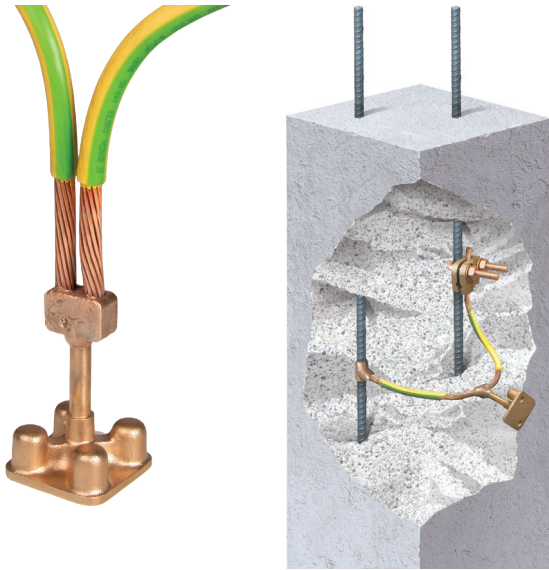

Can be used with bolted clamps or exothermic welds

Kingsmill **Earth Points (with green/yellow tail)** provide bonding points to reinforcing bar.

EARTH POINT	TAIL LENGTH (mm)	NO. OF TAILS	WEIGHT (kg)	PART NO.
EBP1-M8	500	1	0.46	EBP1-M8-T
EBP1	500	1	0.46	EBP1-T
EBP2	500	1	0.63	EBP2-T
EBP2P	500	1	0.75	EBP2P-T
EBP2P-08	500	1	0.75	EBP2P-08-T
EBP2	500	2	0.96	EBP2-2T
EBP2P	500	2	1.08	EBP2P-2T
EBP2P-08	500	2	1.08	EBP2P-08-2T
EBP4	500	1	0.70	EBP4-T
EBP4	500	2	1.05	EBP4-2T

Material: Gunmetal, 70mm² 6491X green/yellow Copper Cable

Standard: BS:EN 62561-1 Class H, BS 7430

Tightening torque: 8Nm

Single Hole Earth Points (with solid tail)



Kingsmill **Single Hole Earth Points (with solid tail)** provide bonding points to reinforcing bar.

FIXING HOLE SIZE	TAIL DIAMETER (mm)	TAIL LENGTH (mm)	MATERIAL	WEIGHT (kg)	PART NO.
M10	10mm	200mm	Stainless Steel	0.22	EBP1SS-M10
M8	10mm	500mm	Gunmetal/Steel	0.55	EBP1-M8-S
M16	16mm	500mm	Gunmetal/Steel	1.20	EBP1-M16-S

Material: Stainless Steel/Gunmetal

Standard: BS:EN 62561-1 Class H, BS 7430

Tightening torque: 8Nm

Pre-Welded Rebar/Earth Points

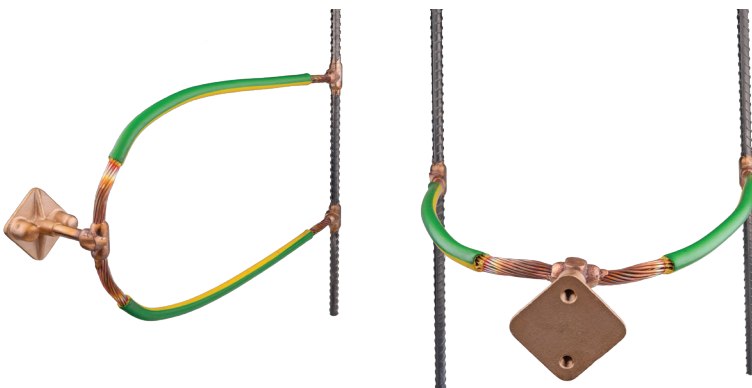

Kingsmill can prefabricate **pre-welded earth point/conductor/rebar** connections. This saves time on site.

Contact Customer Services for details and quotations.

Earth Bosses

Earth Bosses are used for welding to steel vessels, tanks and structures. Wrap connections with Denso Tape to stop moisture ingress.

Supplied complete with A2 stainless steel dowel, flat washer, spring washer & two nuts. Phosphor bronze fixing assembly is available (add “/PB” suffix to the part number).

DIAMETER (mm)	LENGTH (mm)	THREAD SIZE	WEIGHT (kg)	PART NO.
25	25	M8	0.09	EBOSS2525M08
30	30	M8	0.16	EBOSS3030M08
30	30	M10	0.18	EBOSS3030M10
30	40	M8	0.22	EBOSS3040M08
30	40	M10	0.24	EBOSS3040M10
30	50	M8	0.27	EBOSS3050M08
30	50	M10	0.29	EBOSS3050M10
40	30	M10	0.31	EBOSS4030M10
40	30	M12	0.34	EBOSS4030M12
40	40	M10	0.41	EBOSS4040M10
40	40	M12	0.43	EBOSS4040M12
40	50	M10	0.51	EBOSS4050M10
40	50	M12	0.53	EBOSS4050M12
50	30	M10	0.48	EBOSS5030M10
50	30	M12	0.50	EBOSS5030M12
50	40	M10	0.63	EBOSS5040M10
50	40	M12	0.65	EBOSS5040M12
50	50	M10	0.77	EBOSS5050M10
50	50	M12	0.78	EBOSS5050M12

Material: Mild Steel

Standard: BS 970 230M07

OTHER MATERIALS, SIZES AND CONFIGURATIONS AVAILABLE UPON REQUEST.



Static Earth Receptacles

Kingsmill **Static Earth Receptacles** provide a convenient point for attaching portable static discharge wires and clamps to the earth termination, thus safely discharging potentially lethal static voltages.

WIDTH (A) (mm)	HEIGHT (B) (mm)	WEIGHT (kg)	PART NO.
68	90	0.58	SER68
130	160	4.25	SER130

Material: Gunmetal

Standard: BS 7430

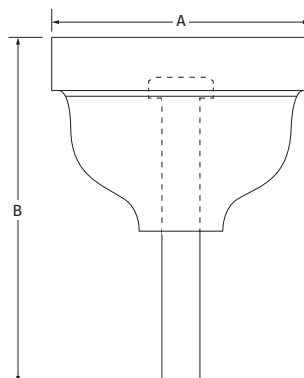

Flexible Flat Copper Braid Bonds

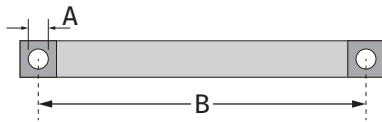
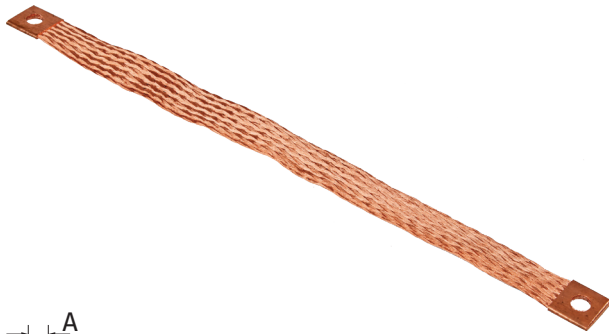

Our pre-terminated **Flexible Flat Copper Braid Bonds** are ideal for bonding of metal doors, gates, fencing etc.

DIMENSIONS (mm)	HOLE DIA. (A) (mm)	LENGTH (B) (mm)	CSA (mm ²)	WEIGHT (kg)	PART NO.
12 x 1	7.0	200	6.0	0.01	FB200/6/7
12 x 1	7.0	400	6.0	0.02	FB400/6/7
15 x 1.5	7.0	200	10	0.02	FB200/10/7
15 x 1.5	7.0	400	10	0.04	FB400/10/7
19 x 2.5	9.0	200	16	0.03	FB200/16/9
19 x 2.5	9.0	400	16	0.06	FB400/16/9
25 x 3	11	200	25	0.05	FB200/25/11
25 x 3	11	400	25	0.10	FB400/25/11
25 x 3.5	11	200	35	0.09	FB200/35/11
25 x 3.5	11	400	35	0.15	FB400/35/11
30 x 5	11	200	50	0.10	FB200/50/11
30 x 5	11	400	50	0.20	FB400/50/11
32 x 6	13	200	70	0.13	FB200/70/13
32 x 6	13	400	70	0.25	FB400/70/13
37 x 6	13	200	95	0.19	FB200/95/13
37 x 6	13	400	95	0.37	FB400/95/13
45 x 6	17	200	120	0.23	FB200/120/17
45 x 6	17	400	120	0.46	FB400/120/17
50 x 8	17	200	150	0.30	FB200/150/17
50 x 8	17	400	150	0.60	FB400/150/17

FIXINGS
Use M8 or M10 brass nuts, bolts and washers

SEE FIXINGS SECTION PAGE FIX:2

Material: Copper

Standard: BS:EN 13602

OTHER MATERIALS, SIZES AND CONFIGURATIONS AVAILABLE UPON REQUEST.

Flexible Flat Copper Braid Bonds (Tinned)

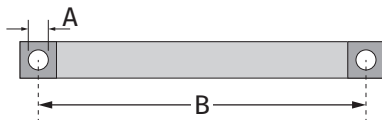

Tinning adds extra corrosion protection to our range of **Flexible Flat Copper Braid Bonds (Tinned)**.

DIMENSIONS (mm)	HOLE DIA. (A) (mm)	LENGTH (B) (mm)	CSA (mm ²)	WEIGHT (kg)	PART NO.
12 X 1	7.0	200	6.0	0.01	FBT200/6/7
12 X 1	7.0	400	6.0	0.02	FBT400/6/7
15 X 1.5	7.0	200	10	0.02	FBT200/10/7
15 X 1.5	7.0	400	10	0.04	FBT400/10/7
19 X 2.5	9.0	200	16	0.03	FBT200/16/9
19 X 2.5	9.0	400	16	0.06	FBT400/16/9
25 X 3	11	200	25	0.05	FBT200/25/11
25 X 3	11	400	25	0.10	FBT400/25/11
25 X 3.5	11	200	35	0.09	FBT200/35/11
25 X 3.5	11	400	35	0.15	FBT400/35/11
30 X 5	11	200	50	0.10	FBT200/50/11
30 X 5	11	400	50	0.20	FBT400/50/11
32 X 6	13	200	70	0.13	FBT200/70/13
32 X 6	13	400	70	0.25	FBT400/70/13
37 X 6	13	200	95	0.19	FBT200/95/13
37 X 6	13	400	95	0.37	FBT400/95/13
45 X 6	17	200	120	0.23	FBT200/120/17
45 X 6	17	400	120	0.46	FBT400/120/17
50 X 8	17	200	150	0.30	FBT200/150/17
50 X 8	17	400	150	0.60	FBT400/150/17

FIXINGS
Use M8 or M10 stainless steel nuts, bolts and washers

SEE FIXINGS SECTION PAGE FIX:2

Material: Tinned Copper

Standard: BS:EN 13602

OTHER MATERIALS, SIZES AND CONFIGURATIONS AVAILABLE UPON REQUEST.

Flexible Flat Aluminium Braid Bonds

Flexible Aluminium Braid Bonds are used for bonding aluminium cladding into the structural Lightning Protection scheme.

DIMENSIONS (mm)	HOLE DIA. (A) (mm)	LENGTH (B) (mm)	CSA (mm ²)	WEIGHT (kg)	PART NO.
30 x 5	M8	200	50	0.03	FBA200/50/9
30 x 5	M8	300	50	0.04	FBA300/50/9
30 x 5	M8	400	50	0.08	FBA400/50/9
30 x 5	M10	200	50	0.03	FBA200/50/11
30 x 5	M10	300	50	0.04	FBA300/50/11
30 x 5	M10	400	50	0.08	FBA400/50/11
32 x 6	M8	200	75	0.06	FBA200/75/9
32 x 6	M8	300	75	0.09	FBA300/75/9
32 x 6	M8	400	75	0.12	FBA400/75/9
32 x 6	M10	200	75	0.06	FBA200/75/11
32 x 6	M10	300	75	0.09	FBA300/75/11
32 x 6	M10	400	75	0.12	FBA400/75/11

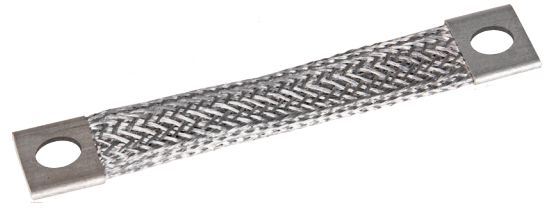

Material: Aluminium
Standard: BS:EN 13602



FIXINGS
 Use M8 or M10 galvanised nuts, bolts and washers



SEE FIXINGS SECTION PAGE FIX:2

OTHER MATERIALS, SIZES AND CONFIGURATIONS AVAILABLE UPON REQUEST.

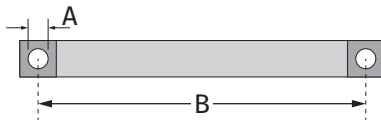

Flexible Circular Copper Braid Bonds

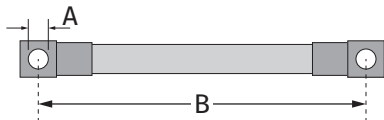

Flexible Circular Copper Braid Bonds are terminated with cable lugs at each end. Use to bond gates, doors, fences etc.

BRAID DIA. (mm)	LENGTH (B) (mm)	HOLE DIA. (A) (mm)	CSA (mm ²)	WEIGHT (kg)	PART NO.
4.2	200	7.0	6.0	0.01	CB200/6/7
4.2	400	7.0	6.0	0.02	CB400/6/7
5.4	200	7.0	10	0.02	CB200/10/7
5.4	400	7.0	10	0.04	CB400/10/7
7.0	200	9.0	16	0.03	CB200/16/9
7.0	400	9.0	16	0.06	CB400/16/9
8.5	200	11	25	0.05	CB200/25/11
8.5	400	11	25	0.10	CB400/25/11
11.5	200	11	50	0.10	CB200/50/11
11.5	400	11	50	0.20	CB400/50/11
14.5	200	13	70	0.13	CB200/70/13
14.5	400	13	70	0.25	CB400/70/13
16.0	200	13	95	0.19	CB200/95/13
16.0	400	13	95	0.37	CB400/95/13

Material: Copper

Standard: BS:EN 13602

FIXINGS
Use M8 or M10 stainless steel nuts, bolts and washers

SEE FIXINGS SECTION PAGE FIX:2

OTHER SIZES, MATERIALS, HOLE SIZES ETC. AVAILABLE ON REQUEST.

Flexible Circular Copper Braid Bonds (Tinned)

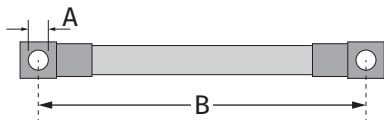

Flexible Circular Copper Braid Bonds (Tinned) are terminated with cable lugs at each end. Use to bond gates, doors, fences etc.

BRAID DIA. (mm)	LENGTH (B) (mm)	HOLE DIA. (A) (mm)	CSA (mm ²)	WEIGHT (kg)	PART NO.
4.2	200	7.0	6.0	0.01	CBT200/6/7
4.2	400	7.0	6.0	0.02	CBT400/6/7
5.4	200	7.0	10	0.02	CBT200/10/7
5.4	400	7.0	10	0.04	CBT400/10/7
7.0	200	9.0	16	0.03	CBT200/16/9
7.0	400	9.0	16	0.06	CBT400/16/9
8.5	200	11	25	0.05	CBT200/25/11
8.5	400	11	25	0.10	CBT400/25/11
11.5	200	11	50	0.10	CBT200/50/11
11.5	400	11	50	0.20	CBT400/50/11
14.5	200	13	70	0.13	CBT200/70/13
14.5	400	13	70	0.25	CBT400/70/13
16.0	200	13	95	0.19	CBT200/95/13
16.0	400	13	95	0.37	CBT400/95/13

Material: Tinned Copper

Standard: BS:EN 13602

FIXINGS
Use M8 or M10 stainless steel nuts, bolts and washers

SEE FIXINGS SECTION PAGE FIX:2

OTHER SIZES, MATERIALS, HOLE SIZES ETC. AVAILABLE ON REQUEST.

Flexible Flat Copper Braids

Flexible Flat Copper Braid (Plain) is suitable for applications of earth bonding. The braid can also be supplied as standard pre-cut and drilled braid bonds (see page BOND:10).

OVERALL NOMINAL SIZE (mm)	CSA (mm ²)	WEIGHT (kg/m)	PART NO.
12 x 1.0	6	0.055	FCB1201
15 x 1.5	10	0.096	FCB1515
19 x 2.5	16	0.16	FCB1925
25 x 3.0	25	0.25	FCB2530
25 x 3.5	35	0.34	FCB2535
30 x 5.0	50	0.49	FCB3050
32 x 6.0	70	0.63	FCB3260
37 x 6.0	95	0.93	FCB3760
45 x 6.0	120	1.15	FCB4560
50 x 8.0	150	1.45	FCB5080

Material: Copper

Standard: BS:EN 13602

OTHER SIZES, MATERIALS, HOLE SIZES ETC. AVAILABLE ON REQUEST.

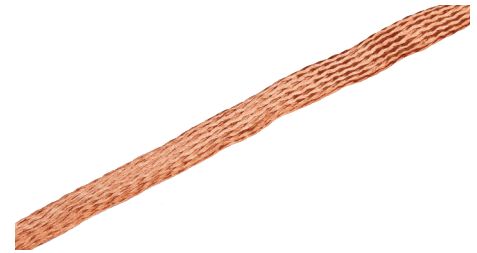

Flexible Flat Copper Braids (Tinned)

Flexible Flat Copper Braid (Tinned) is suitable for applications of earth bonding. The braid can also be supplied as standard pre-cut and drilled braid bonds (see page BOND:10).

OVERALL NOMINAL SIZE (mm)	CSA (mm ²)	WEIGHT (kg/m)	PART NO.
12 x 1.0	6.0	0.055	FCBT1201
15 x 1.5	10	0.096	FCBT1515
19 x 2.5	16	0.16	FCBT1925
25 x 3.0	25	0.25	FCBT2530
25 x 3.5	35	0.34	FCBT2535
30 x 5.0	50	0.49	FCBT3050
32 x 6.0	70	0.63	FCBT3260
37 x 6.0	95	0.93	FCBT3760
45 x 6.0	120	1.15	FCBT4560
50 x 8.0	150	1.45	FCBT5080

Material: Tinned Copper

Standard: BS:EN 13602

OTHER SIZES, MATERIALS, HOLE SIZES ETC. AVAILABLE ON REQUEST.



Bare Copper Expansion Bonds

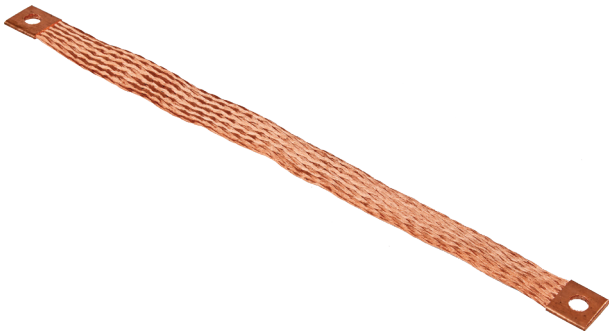

Bare Copper Expansion Bonds absorb movement caused by the electromechanical effects of a direct lightning strike to the Lightning Protection network. **Expansion Bonds** also absorb movement due to temperature and climate changes.

DIMENSIONS (mm)	HOLE DIA. (mm)	LENGTH (mm)	CSA (mm ²)	WEIGHT (kg)	PART NO.
30 x 5 x 200	M8	200	50	0.13	FB200/50/9
30 x 5 x 200	M10	200	50	0.13	FB200/50/11
32 x 6 x 200	M8	200	75	0.20	FB200/75/9
32 x 6 x 200	M10	200	75	0.20	FB200/75/11

Material: Copper

Standard: BS:EN 13602

FIXINGS
Use M8 or M10 brass nuts, bolts and washers

SEE FIXINGS SECTION PAGE FIX:2

OTHER SIZES, MATERIALS, HOLE SIZES ETC. AVAILABLE ON REQUEST.

Tinned Copper Expansion Bonds

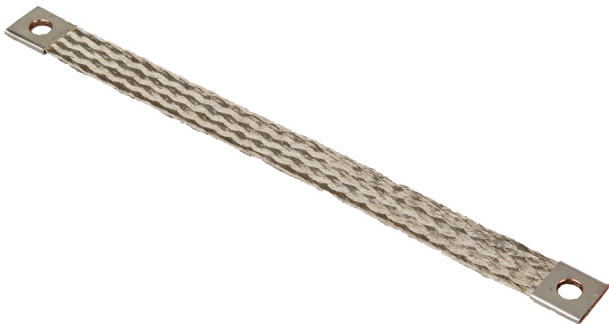

Tinned Copper Expansion Bonds absorb movement caused by the electromechanical effects of a direct lightning strike to the Lightning Protection network. **Tinned Copper Expansion Bonds** also absorb movement due to temperature and climate changes.

DIMENSIONS (mm)	HOLE DIA. (mm)	LENGTH (mm)	CSA (mm ²)	WEIGHT (kg)	PART NO.
30 x 5 x 200	M8	200	50	0.14	FBT200/50/9
30 x 5 x 200	M10	200	50	0.14	FBT200/50/11
32 x 6 x 200	M8	200	75	0.21	FBT200/75/9
32 x 6 x 200	M10	200	75	0.21	FBT200/75/11

Material: Tinned Copper

Standard: BS:EN 13602

FIXINGS
Use M8 or M10 stainless steel nuts, bolts and washers

SEE FIXINGS SECTION PAGE FIX:2

OTHER SIZES, MATERIALS, HOLE SIZES ETC. AVAILABLE ON REQUEST.

Aluminium Expansion Bonds

Aluminium Expansion Bonds absorb movement caused by the electromechanical effects of a direct lightning strike to the Lightning Protection network. **Aluminium Expansion Bonds** also absorb movement due to temperature and climate changes.

DIMENSIONS (mm)	HOLE DIA. (mm)	LENGTH (mm)	CSA (mm ²)	WEIGHT (kg)	PART NO.
30 x 5 x 200	M8	200	50	0.03	FBA200/50/9
30 x 5 x 200	M10	200	50	0.03	FBA200/50/11
32 x 6 x 200	M8	200	75	0.06	FBA200/75/9
32 x 6 x 200	M10	200	75	0.06	FBA200/75/11

Material: Aluminium

Standard: BS:EN 13602



OTHER SIZES, MATERIALS, HOLE SIZES ETC. AVAILABLE ON REQUEST.

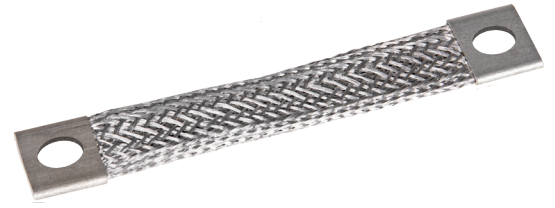

Split Bolt Connectors

Kingsmill **Split Bolt Connectors** will accept a range of stranded or solid circular conductors. No specialist tools are required for installation.

MAIN: Minimum - Maximum (mm ²)	TAP: Minimum - Maximum (mm ²)	WEIGHT (kg)	PART NO.
4 - 10	2.5 - 10	0.02	SBC8
10 - 16	2.5 - 16	0.03	SBC4
16 - 25	4 - 25	0.04	SBC2
25 - 35	4 - 35	0.06	SBC1
35 - 50	4 - 50	0.09	SBC10
35 - 70	4 - 70	0.14	SBC20
50 - 95	4 - 95	0.17	SBC30
50 - 120	6 - 120	0.18	SBC40
95 - 185	6 - 185	0.35	SBC50

Material: High Strength Copper Alloy

Standard: BS 7430



C Crimp Connectors

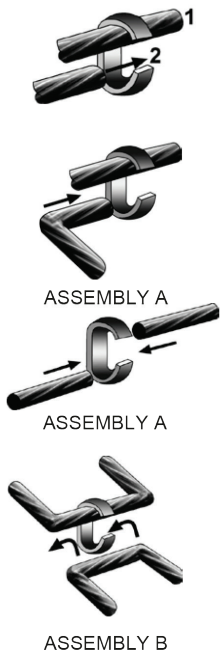
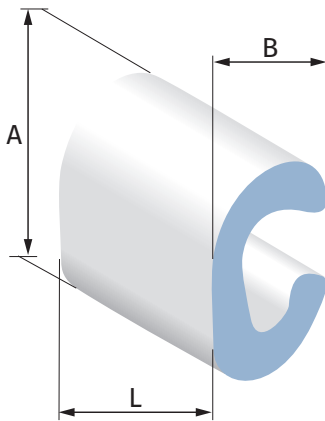
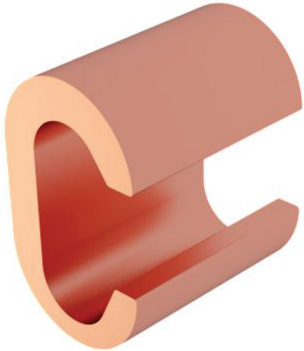

Kingsmill **C Crimp Connectors** are manufactured from high purity copper profiles and are suitable for a variety of uses, either to create an earthing network or tapping off overhead distribution lines.

Kingsmill **C Crimp Connectors** are designed to allow connections to cable to be formed without the need to cut the main cable.

We also supply a range of sizes in either plain or tinned finish.

CAPACITIES (mm ²)						ASSEMBLY	PART NO.	
TOTALS		MINIMUM		MAXIMUM			COPPER	TIN PLATED COPPER
Min	Max	Run	Tap	Run	Tap			
3	12	1.5	1.5	6	6	A	C6	C6E
13	20	10	2 x 1.5	10	10	A	C10	C10E
19	32	10	9 2 x 1.5	16	16	A + B	C16	C16E
17	35	16	1.5	25	25	A	C25-10	C25-10E
35	41	25	10	25	25	A + B	C25PM	C25PME
33	56	25	10	29.3	29.3	A	C25	C25E
		27	6	35	35	A + B		
		30	2 x 1.5	50	30	A + B		
53	70	30	25	35	35	A + B	C35	C35E
		50	2 x 1.5	50	50	A + B		
66	100	50	16	50	50	A	C50	C50E
		63	2 x 1.5	70	70	A		
				75	75	A		
54	110	50	4	70	70	A	C70-35	C70-35E
85	140	50	35	70	70	A	C70	C70E
105	170	75	30	95	95	A + B	C75	C75E
		70	35	95	95	A + B		
		90	16					
99	140	95	4	100	100	A	C95-35	C95-35E
150	190	75	75	95	95	A	C95	C95E
156	240	120	35	120	120	A	C120	C120E
		150	6	150	150	A		
225	300	150	75	150	150	A + B	C150	C150E
260	300	185	75			A + B	C185-95	C185-95E
210	370	115	95	185	185	A + B	C185	C185E
		150	60	185	185	A + B		
387	480	240	147	240	240	A	C240	C240E

Material: Copper

Standard: BS:EN 12163

Isolating Spark Gap (connecting pins)

Encapsulated high-performance Isolating Spark Gap with connecting pins.

Features

- 100kA
- Class H - heavy duty
- Easy installation

Benefits

Suitable for use where direct connection is not allowed.

Application

Use for indirect earthing of isolated conductive parts.

Standards

EN 61643-11 (for surge protection devices).



Electrical specification

Order number	KMSG-A100	
Lightning impulse current	I_{imp}	100kA
Rated impulse sparkover voltage	U_{rimp}	5kV
Rated power frequency withstand voltage	U_{WAC}	2.5kV
Isolation resistance		100M Ω
Classification		Class H - heavy duty
Degree of protection		IP67
Range of operating temperatures (min - max)		-40°C - +80°C
According to standard		EN 62561-3:2012, IEC 62561-3:2012
Weight		195g (nett), 255g (gross)

Dimensions and wiring diagram

KMSG-A100

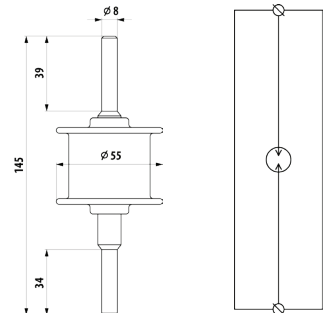

Isolating Spark Gap (M8 bolts)

Encapsulated high-performance Isolating Spark Gap with M8 bolts.

Features

- 50kA
- Class N - normal duty
- Easy installation

Benefits

Suitable for use where direct connection is not allowed.

Application

Use for indirect earthing of isolated conductive parts.

Standards

EN 61643-11 (for surge protection devices).



Electrical specification

Order number	KMSG-100	
Lightning impulse current	I_{imp}	50kA
Rated impulse sparkover voltage	U_{rimp}	0.95kV
Rated power frequency withstand voltage	U_{WAC}	0.07kV
Rated DC withstand voltage	U_{WDC}	0.1kV
Isolation resistance		100M Ω
Classification		Class N - normal duty
Degree of protection		IP67
Range of operating temperatures (min - max)		-40°C - +80°C
According to standard		EN 62561-3:2012, IEC 62561-3:2012
Weight		145g (nett), 125g (gross)

Dimensions and wiring diagram

KMSG-100

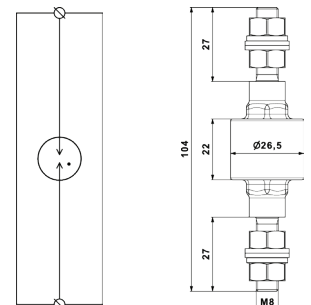

Isolating Spark Gap (connecting cables)



Encapsulated high-performance Isolating Spark Gap with connecting cables.

Features

- 50kA
- Class N - normal duty
- Easy installation

Benefits

Suitable for use where direct connection is not allowed.

Application

For indirect earthing of isolated conductive parts.

Standards

EN 61643-11 (for surge protection devices).

Dimensions and wiring diagram

KMSG-C100

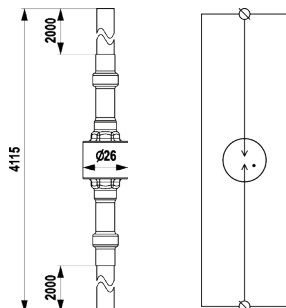

Electrical specification

Order number	KMSG-C100	
Lightning impulse current	I_{imp}	50kA
Rated impulse sparkover voltage	U_{rimp}	0.95kV
Rated power frequency withstand voltage	U_{WAC}	0.07kV
Rated DC withstand voltage	U_{WDC}	0.1kV
Isolation resistance	100MΩ	
Classification	Class N - normal duty	
Degree of protection	IP67	
Range of operating temperatures (min - max)	-40°C - +80°C	
According to standard	EN 62561-3:2012, IEC 62561-3:2012	
Weight	1600g (nett), 1610g (gross)	

Isolating Spark Gap (M8 bolt and nut)



Encapsulated high-performance Isolating Spark Gap with M8 bolt and nut.

Features

- 100kA
- Class H - heavy duty
- Easy installation

Benefits

Suitable for use where direct connection is not allowed.

Application

For indirect earthing of isolated conductive parts.

Standards

EN 61643-11 (for surge protection devices).

Dimensions and wiring diagram

KMSGO-500

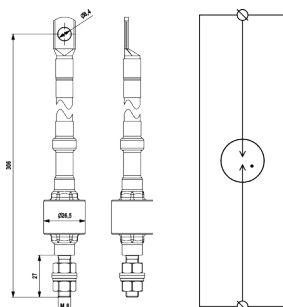

Electrical specification

Order number	KMSGO-500	
Lightning impulse current	I_{imp}	100kA
Rated impulse sparkover voltage	U_{rimp}	1.50kV
Rated power frequency withstand voltage	U_{WAC}	0.35kV
Rated DC withstand voltage	U_{WDC}	0.50kV
Isolation resistance	100MΩ	
Classification	Class H - heavy duty	
Degree of protection	IP67	
Range of operating temperatures (min - max)	-40°C - +80°C	
According to standard	EN 62561-3:2012, IEC 62561-3:2012	
ETIM Class	EC000510	
Weight	235g (nett), 255g (gross)	